

# BCT5-S18-UN6X2T-H1151

## Capacitive Sensor

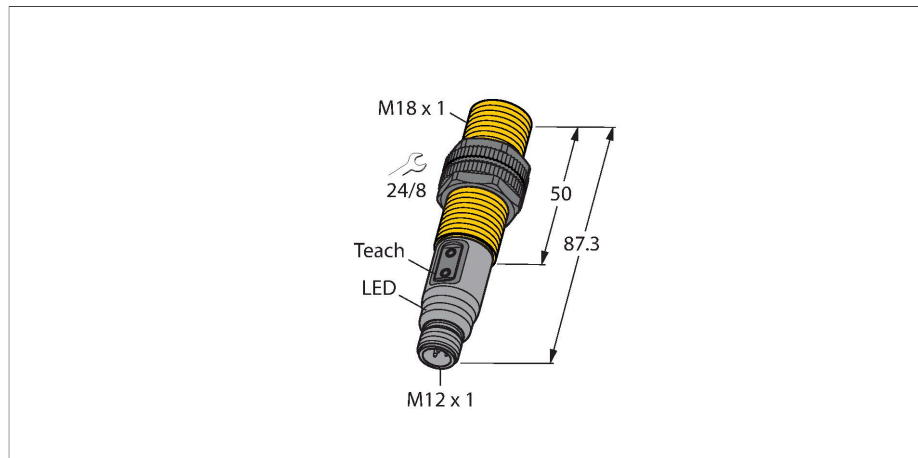

### Features

- M18 × 1 threaded barrel
- Plastic, PA12-GF30
- Teach-in and configuration via buttons on the device, pin 5 and IO-Link

### Wiring diagram

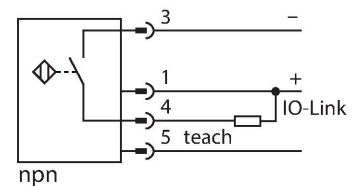

### Technical data

Type	BCT5-S18-UN6X2T-H1151
ID	2101200
Remark to product	For remote teaching via pin 5 please use 5-wire cable (e.g. RKC4.5T.../WKC4.5T...)
Rated switching distance (flush)	5 mm
Rated switching distance (non-flush)	7.5 mm
Secured operating distance	$\leq (0.72 \times S_n)$
Hysteresis	1...20 %
Temperature drift	Typical 20 %
Repeat accuracy	$\leq 2$ % of full scale
Ambient temperature	-25...+70 °C
<b>Electrical data</b>	
Operating voltage	10...30 VDC
Residual ripple	$\leq 10$ % $U_{ss}$
DC rated operational current	$\leq 200$ mA
No-load current	$\leq 15$ mA
Residual current	$\leq 0.1$ mA
Switching frequency	0.01 kHz
Oscillation frequency	According to EN 60947-5-2, 8.2.6.2 Table 9: 0.1...2.0 MHz
Isolation test voltage	$\leq 0.5$ kV
Communication protocol	IO-Link
Output function	3-wire, NO/NC, NPN
Short-circuit protection	yes / Cyclic
Voltage drop at $I_o$	$\leq 2.4$ V
Wire breakage/Reverse polarity protection	yes / Complete

### Functional principle

Capacitive proximity switches are designed for non-contact and wear-free detection of electrically conductive as well as non-conductive metal objects.

## Technical data

Tests/approvals	
Approvals	UL
UL registration number	E210608
IO-Link	
IO-Link specification	V 1.1
Programming	FDT/DTM
Transmission physics	corresponds to 3-wire physics (PHY2)
Transmission rate	COM 2/38.4 kbps
Process data width	16 bit
Measured value information	12 bit
Frame type	2.2
Included in the SIDI GSDML	Yes
Mechanical data	
Design	Threaded barrel, M18 × 1
Dimensions	87.3 mm
Housing material	Plastic, PA12-GF30, PEI
Active area material	PA12-GF30, yellow
Admissible pressure on front cap	≤ 6 bar
Max. tightening torque of housing nut	2 Nm
Electrical connection	Connector, M12 × 1
Vibration resistance	55 Hz (1 mm)
Shock resistance	30 g (11 ms)
Protection class	IP67
MTTF	1080 years acc. to SN 29500 (Ed. 99) 40 °C
Switching state	LED, Yellow

## Mounting instructions

## Product features

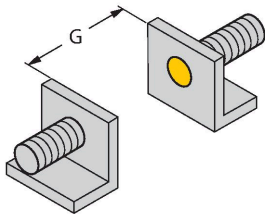

Distance D 36 mm

Distance W 15 mm

Distance S 27 mm

Distance G 30 mm

Diameter active area B  $\varnothing$  18 mm

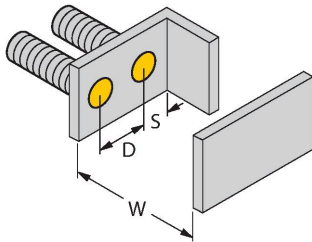

The given minimum distances have been checked against the standard switching distance.  
Should the sensitivity of the sensors be changed via potentiometer, the data sheet specifications no longer apply.

## Accessories

BS 18

69471

Mounting clamp for threaded barrel sensors; material: PA66-GF

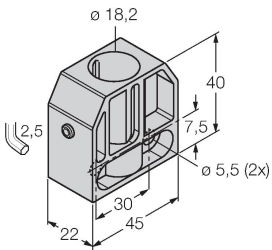

BSN 18

69472

Mounting clamp for threaded barrel sensors; material: PA66-GF

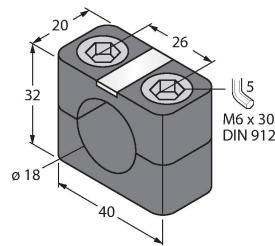

BST-18B

6947214

Mounting clamp for threaded barrel sensors, with dead-stop; material: PA6

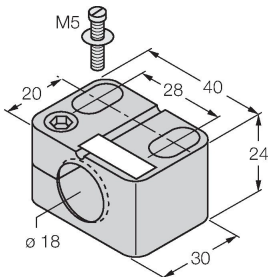

MAP-M18

6950012

Mounting adapter; material: Polypropylene; sensor replacement with filled container possible (adapter remains in container during sensor replacement)

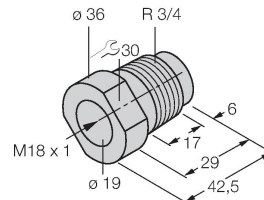

## Accessories

Dimension drawing

Type

ID

RKC4.4T-2/TXL

6625503

Connection cable, female M12, straight, 4-pin, cable length: 2 m, sheath material: PUR, black; cULus approval; other cable lengths and qualities available, see [www.turck.com](http://www.turck.com)

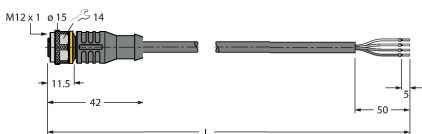

Dimension drawing	Type	ID	
	WKC4.4T-2/TXL	6625515	Connection cable, female M12, angled, 4-pin, cable length: 2 m, sheath material: PUR, black; cULus approval; other cable lengths and qualities available, see <a href="http://www.turck.com">www.turck.com</a>
	WKC4.4T-2/TEL	6625025	Connection cable, female M12, angled, 4-pin, cable length: 2 m, sheath material: PVC, black; cULus approval; other cable lengths and qualities available, see <a href="http://www.turck.com">www.turck.com</a>
	RKC4.4T-2/TEL	6625013	Connection cable, female M12, straight, 4-pin, cable length: 2 m, sheath material: PVC, black; cULus approval; other cable lengths and qualities available, see <a href="http://www.turck.com">www.turck.com</a>

## Accessories

Dimension drawing	Type	ID	
	TX1-Q20L60	6967114	Teach adapter for inductive encoders, linear position, angle, ultrasonic and capacitive sensors
	TBEN-S2-4IOL	6814024	Compact multiprotocol I/O module, 4 IO-Link Master 1.1 Class A, 4 universal PNP digital channels 0.5 A

Dimension drawing	Type	ID	
	USB-2-IOL-0002	6825482	IO-Link Master with integrated USB port

