

# BC5-M18-AP4X-H1141/S250

## Capacitive Sensor

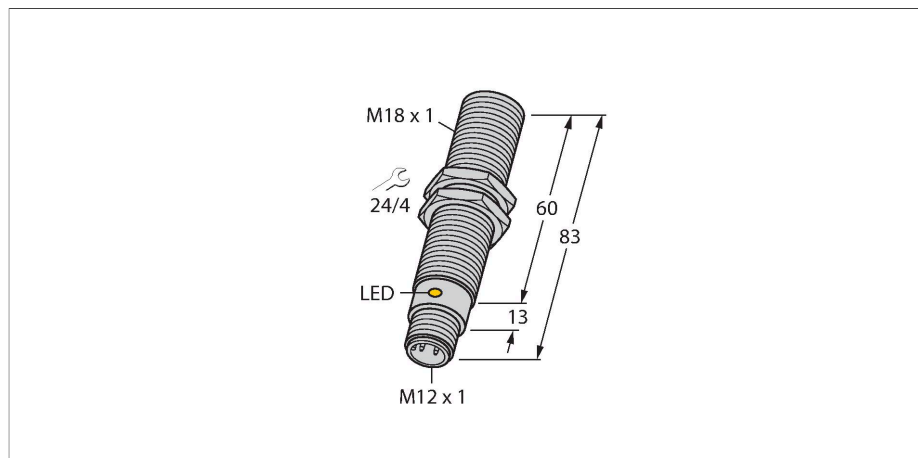

### Features

- M18 × 1 threaded barrel
- Chrome-plated brass
- Fixed settings
- DC 3-wire, 10...65 VDC
- NO contact, PNP output
- M12 × 1 connector

### Wiring diagram

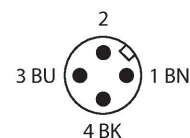
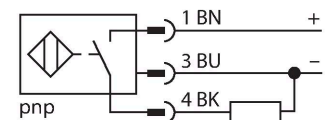

### Functional principle

Capacitive proximity switches are designed for non-contact and wear-free detection of electrically conductive as well as non-conductive metal objects.

### Technical data

Type	BC5-M18-AP4X-H1141/S250
ID	2504024
Rated switching distance (flush)	5 mm
Rated switching distance (non-flush)	5 mm
Secured operating distance	$\leq (0.72 \times S_n)$
Hysteresis	1...20 %
Temperature drift	Typical 20 %
Repeat accuracy	$\leq 2$ % of full scale
Ambient temperature	-25...+70 °C
<b>Electrical data</b>	
Operating voltage	10...65 VDC
Residual ripple	$\leq 10$ % $U_{ss}$
DC rated operational current	$\leq 200$ mA
No-load current	$\leq 15$ mA
Residual current	$\leq 0.1$ mA
Switching frequency	0.1 kHz
Oscillation frequency	According to EN 60947-5-2, 8.2.6.2 Table 9: 0.1...2.0 MHz
Isolation test voltage	$\leq 0.5$ kV
Output function	3-wire, NO contact, PNP
Short-circuit protection	yes / Cyclic
Voltage drop at $I_o$	$\leq 1.8$ V
Wire breakage/Reverse polarity protection	yes / Complete
<b>Tests/approvals</b>	
Approvals	UL
UL registration number	E210608

## Technical data

Mechanical data	
Design	Threaded barrel, M18 × 1
Dimensions	83 mm
Housing material	Metal, CuZn, Chrome-plated
Active area material	PBT-GF30-V0, yellow
Admissible pressure on front cap	≤ 4 bar
Max. tightening torque of housing nut	25 Nm
Electrical connection	Connector, M12 × 1
Vibration resistance	55 Hz (1 mm)
Shock resistance	30 g (11 ms)
Protection class	IP67
MTTF	1080 years acc. to SN 29500 (Ed. 99) 40 °C
Switching state	LED, Yellow

## Mounting instructions

### Product features

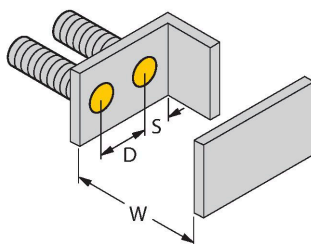
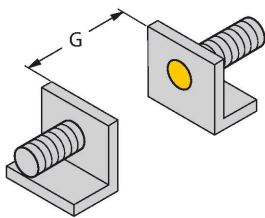

Distance D	36 mm
------------	-------

Distance W	15 mm
------------	-------

Distance S	27 mm
------------	-------

Distance G	30 mm
------------	-------

Diameter active area B	Ø 18 mm
------------------------	---------

The given minimum distances have been checked against the standard switching distance.  
Should the sensitivity of the sensors be changed via potentiometer, the data sheet specifications no longer apply.

## Accessories

BS 18

69471

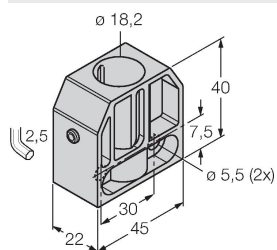

Mounting clamp for threaded barrel sensors; material: PA66-GF

BSN 18

69472

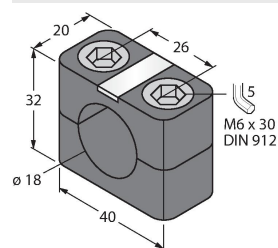

Mounting clamp for threaded barrel sensors; material: PA66-GF

## BST-18B

6947214

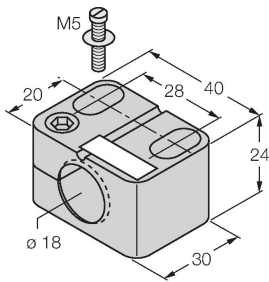

Mounting clamp for threaded barrel sensors, with dead-stop; material: PA6

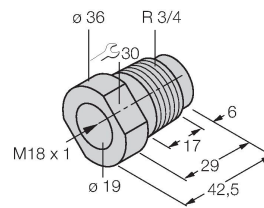

## MAP-M18

6950012

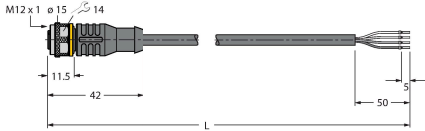
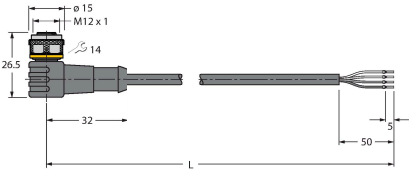
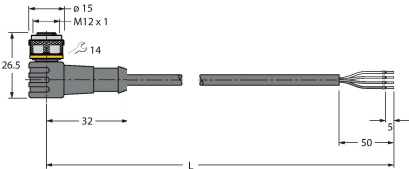

Mounting adapter; material: Polypropylene; sensor replacement with filled container possible (adapter remains in container during sensor replacement)

## Accessories

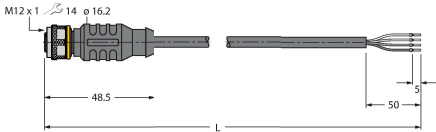
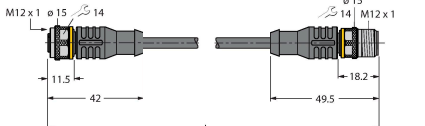
Dimension drawing	Type	ID	
	RKC4.4T-2/TXL	6625503	Connection cable, female M12, straight, 4-pin, cable length: 2 m, sheath material: PUR, black; cULus approval; other cable lengths and qualities available, see <a href="http://www.turck.com">www.turck.com</a>
	WKC4.4T-2/TXL	6625515	Connection cable, female M12, angled, 4-pin, cable length: 2 m, sheath material: PUR, black; cULus approval; other cable lengths and qualities available, see <a href="http://www.turck.com">www.turck.com</a>
	WKC4.4T-2/TEL	6625025	Connection cable, female M12, angled, 4-pin, cable length: 2 m, sheath material: PVC, black; cULus approval; other cable lengths and qualities available, see <a href="http://www.turck.com">www.turck.com</a>
	RKC4.4T-2/TEL	6625013	Connection cable, female M12, straight, 4-pin, cable length: 2 m, sheath material: PVC, black; cULus approval; other cable lengths and qualities available, see <a href="http://www.turck.com">www.turck.com</a>
	RKC4.4T-P7X2-10/TXL	6626184	Connection cable, female M12, angled, 4-pin, cable length: 10m, sheath material: PUR, black; cULus approval; other cable lengths and qualities available, see <a href="http://www.turck.com">www.turck.com</a>
	RKC4.4T-2-RSC4.4T/TEL	6625208	Connection cable, M12 female plug, straight, 4-pin, cable length: 2 m, sheath material: PVC, black; cULus approval; other cable lengths and qualities available, see <a href="http://www.turck.com">www.turck.com</a>

Dimension drawing	Type	ID	Description
	RKC4.4T-2-RSC4.4T/TXL	6625608	Extension cable, M12 female connector, straight, 4-pin to M12 male connector, straight, 4-pin; cable length: 2 m, jacket material: PUR, black; cULus approval; other cable lengths and versions available, see <a href="http://www.turck.com">www.turck.com</a>
	RKC4.4T-2-WSC4.4T/TXL	6625624	Extension cable, M12 female connector, straight, 4-pin; M12 male connector, angled, 4-pin; cable length: 2 m, jacket material: PUR, black; cULus approval; other cable lengths and qualities available, see <a href="http://www.turck.com">www.turck.com</a>
	WKC4.4T-2-WSC4.4T/TXL	6625656	Extension cable, M12 female connector, angled, 4-pin; M12 connector, angled, 4-pin; cable length: 2 m, jacket material: PUR, black; cULus approval; other cable lengths and qualities available, see <a href="http://www.turck.com">www.turck.com</a>