

BC10-S30-VN4X-H1141

Capacitive Sensor

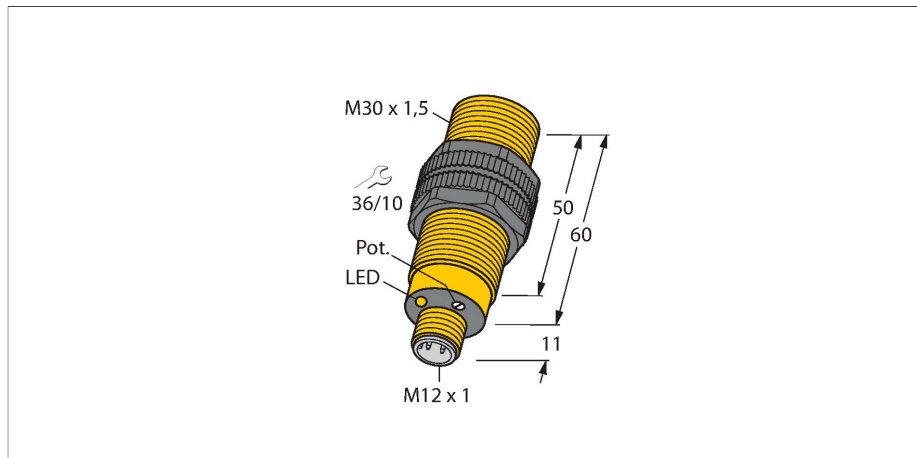

Features

- M30 × 1.5 threaded barrel
- Plastic, PA12-GF30
- Fine adjustment via potentiometer
- DC 4-wire, 10...65 VDC
- Complementary contact, NPN output
- M12 × 1 connector

Wiring diagram

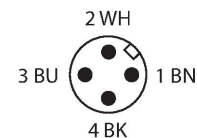
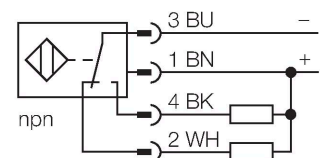

Functional principle

Capacitive proximity switches are designed for non-contact and wear-free detection of electrically conductive as well as non-conductive metal objects.

Technical data

Type	BC10-S30-VN4X-H1141
ID	2506010
Rated switching distance (flush)	10 mm
Rated switching distance (non-flush)	15 mm
Secured operating distance	≤ (0.72 × Sn)
Hysteresis	1...20 %
Temperature drift	Typical 20 %
Repeat accuracy	≤ 2 % of full scale
Ambient temperature	-25...+70 °C
Electrical data	
Operating voltage	10...65 VDC
Residual ripple	≤ 10 % U _{ss}
DC rated operational current	≤ 200 mA
No-load current	≤ 15 mA
Residual current	≤ 0.1 mA
Switching frequency	0.1 kHz
Oscillation frequency	According to EN 60947-5-2, 8.2.6.2 Table 9: 0.1...2.0 MHz
Isolation test voltage	≤ 0.5 kV
Output function	4-wire, Complementary contact, NPN
Short-circuit protection	yes / Cyclic
Voltage drop at I _o	≤ 1.8 V
Wire breakage/Reverse polarity protection	yes / Complete
Tests/approvals	
Approvals	UL
UL registration number	E210608

Technical data

Mechanical data	
Design	Threaded barrel, M30 × 1.5
Dimensions	60 mm
Housing material	Plastic, PA12-GF30, PEI
Active area material	PA12-GF30, yellow
Admissible pressure on front cap	≤ 3 bar
Max. tightening torque of housing nut	5 Nm
Electrical connection	Connector, M12 × 1
Vibration resistance	55 Hz (1 mm)
Shock resistance	30 g (11 ms)
Protection class	IP67
MTTF	1080 years acc. to SN 29500 (Ed. 99) 40 °C
Switching state	LED, Yellow

Mounting instructions

Product features

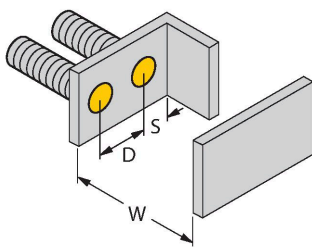
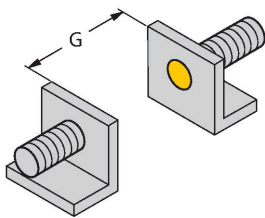

Distance D	60 mm
------------	-------

Distance W	30 mm
------------	-------

Distance S	45 mm
------------	-------

Distance G	60 mm
------------	-------

Diameter active area B	Ø 30 mm
------------------------	---------

The given minimum distances have been checked against the standard switching distance.
Should the sensitivity of the sensors be changed via potentiometer, the data sheet specifications no longer apply.

Accessories

MAP-M30

6950013

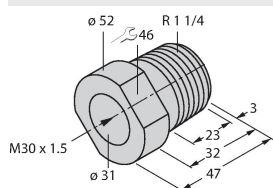

Mounting adapter; material: Polypropylene; sensor replacement with filled container possible (adapter remains in container during sensor replacement)

BST-30B

6947216

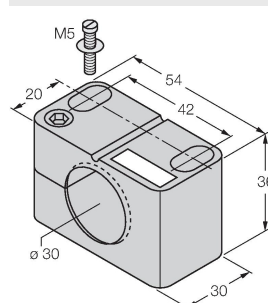

Mounting clamp for threaded barrel sensors, with dead-stop; material: PA6

Accessories

Dimension drawing	Type	ID	
	RKC4.4T-2/TXL	6625503	Connection cable, female M12, straight, 4-pin, cable length: 2 m, sheath material: PUR, black; cULus approval; other cable lengths and qualities available, see www.turck.com
	WKC4.4T-2/TXL	6625515	Connection cable, female M12, angled, 4-pin, cable length: 2 m, sheath material: PUR, black; cULus approval; other cable lengths and qualities available, see www.turck.com
	WKC4.4T-2/TEL	6625025	Connection cable, female M12, angled, 4-pin, cable length: 2 m, sheath material: PVC, black; cULus approval; other cable lengths and qualities available, see www.turck.com
	RKC4.4T-2/TEL	6625013	Connection cable, female M12, straight, 4-pin, cable length: 2 m, sheath material: PVC, black; cULus approval; other cable lengths and qualities available, see www.turck.com
	RKC4.4T-P7X2-10/TXL	6626184	Connection cable, female M12, angled, 4-pin, cable length: 10m, sheath material: PUR, black; cULus approval; other cable lengths and qualities available, see www.turck.com
	RKC4.4T-2-RSC4.4T/TEL	6625208	Connection cable, M12 female plug, straight, 4-pin, cable length: 2 m, sheath material: PVC, black; cULus approval; other cable lengths and qualities available, see www.turck.com
	RKC4.4T-2-RSC4.4T/TXL	6625608	Extension cable, M12 female connector, straight, 4-pin to M12 male connector, straight, 4-pin; cable length: 2 m, jacket material: PUR, black; cULus approval; other cable lengths and versions available, see www.turck.com

Dimension drawing	Type	ID	
	RKC4.4T-2-WSC4.4T/TXL	6625624	Extension cable, M12 female connector, straight, 4-pin; M12 male connector, angled, 4-pin; cable length: 2 m, jacket material: PUR, black; cULus approval; other cable lengths and qualities available, see www.turck.com
	WKC4.4T-2-WSC4.4T/TXL	6625656	Extension cable, M12 female connector, angled, 4-pin; M12 connector, angled, 4-pin; cable length: 2 m, jacket material: PUR, black; cULus approval; other cable lengths and qualities available, see www.turck.com