

BC3-S12-RP6X

Capacitive Sensor

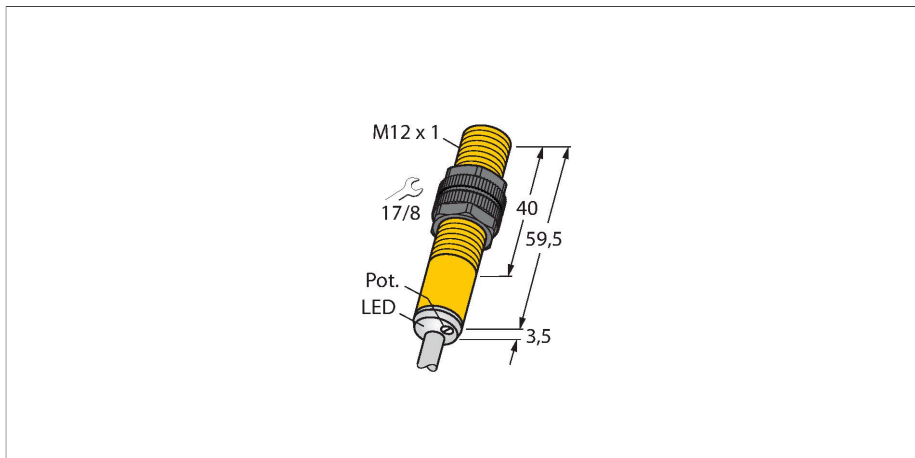

Technical data

Type	BC3-S12-RP6X
ID	2601202
Rated switching distance (flush)	3 mm
Rated switching distance (non-flush)	4.5 mm
Secured operating distance	$\leq (0.72 \times S_n)$
Hysteresis	1...20 %
Temperature drift	Typical 20 %
Repeat accuracy	$\leq 2 \%$ of full scale
Ambient temperature	-25...+70 °C
Electrical data	
Operating voltage	10...30 VDC
Residual ripple	$\leq 10 \%$ U_{ss}
DC rated operational current	≤ 200 mA
No-load current	≤ 15 mA
Residual current	≤ 0.1 mA
Switching frequency	0.1 kHz
Oscillation frequency	According to EN 60947-5-2, 8.2.6.2 Table 9: 0.1...2.0 MHz
Isolation test voltage	≤ 0.5 kV
Output function	3-wire, NC contact, PNP
Short-circuit protection	yes / Cyclic
Voltage drop at I_o	≤ 1.8 V
Wire breakage/Reverse polarity protection	yes / Complete
Tests/approvals	
Approvals	UL
UL registration number	E210608

Features

- M12 × 1 threaded barrel
- Plastic, PA12-GF30
- Fine adjustment via potentiometer
- DC 3-wire, 10...30 VDC
- NC contact, PNP output
- Cable connection

Wiring diagram

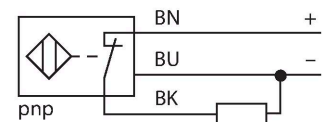

Functional principle

Capacitive proximity switches are designed for non-contact and wear-free detection of electrically conductive as well as non-conductive metal objects.

Technical data

Mechanical data	
Design	Threaded barrel, M12 × 1
Housing material	Plastic, PA12-GF30
Active area material	PA12-GF30
Admissible pressure on front cap	≤ 8 bar
Max. tightening torque of housing nut	1 Nm
Electrical connection	Cable
Cable quality	Ø 5.2 mm, LifYY, PVC, 2 m
Core cross-section	3 x 0.5 mm ²
Vibration resistance	55 Hz (1 mm)
Shock resistance	30 g (11 ms)
Protection class	IP67
MTTF	1080 years acc. to SN 29500 (Ed. 99) 40 °C
Switching state	LED, Yellow

Mounting instructions

Product features

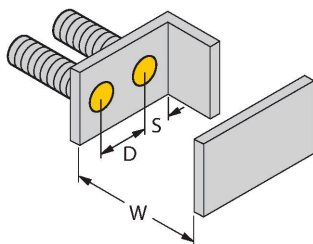
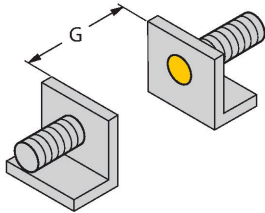

Distance D	24 mm
------------	-------

Distance W	9 mm
------------	------

Distance S	18 mm
------------	-------

Distance G	18 mm
------------	-------

Diameter active area B	Ø 12 mm
------------------------	---------

The given minimum distances have been checked against the standard switching distance. Should the sensitivity of the sensors be changed via potentiometer, the data sheet specifications no longer apply.

Accessories

MAP-M12-PP

6950016

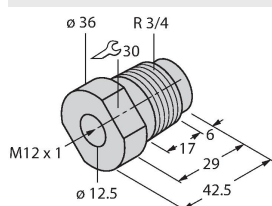

Mounting adapter; material: Polypropylene; sensor replacement with filled container possible (adapter remains in container during sensor replacement)

MAP-M12-PVDF

6950017

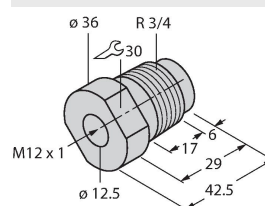

Mounting adapter; material: Polyvinylidenflourid; sensor can be replaced with filled container (adapter remains in container during replacement)

BST-12B

6947212

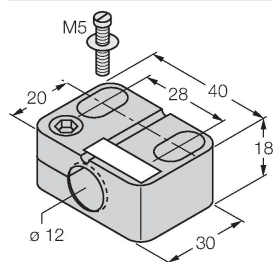

Mounting clamp for threaded barrel sensors, with dead-stop; material: PA6