

BC3-S12-RP6X/S90/3GD

Capacitive Sensor

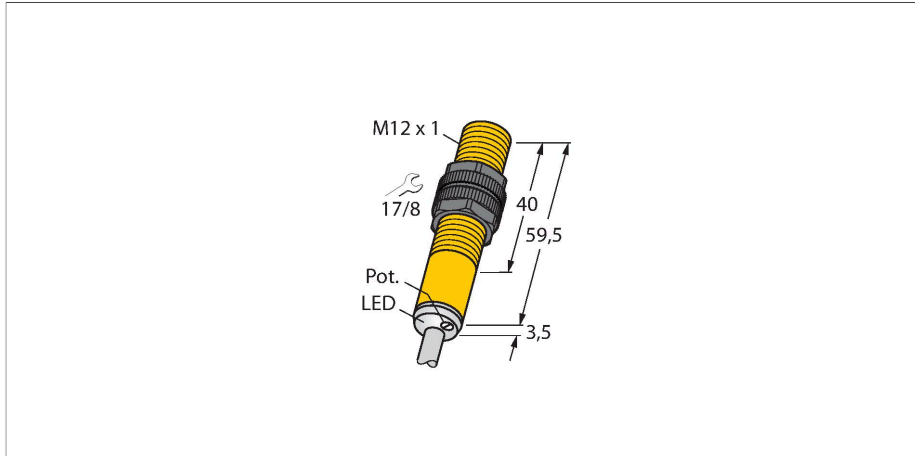

Technical data

| | |
|--------------------------------------|---|
| Type | BC3-S12-RP6X/S90/3GD |
| ID | 2601204 |
| Rated switching distance (flush) | 3 mm |
| Rated switching distance (non-flush) | 4.5 mm |
| Secured operating distance | $\leq (0.72 \times S_n)$ |
| Hysteresis | 1...20 % |
| Temperature drift | Typical 20 % |
| Repeat accuracy | ≤ 2 % of full scale |
| Ambient temperature | -25...+70 °C |
| | For explosion hazardous areas see instruction leaflet |

| Electrical data | |
|---|---|
| Operating voltage | 10...30 VDC |
| Residual ripple | ≤ 10 % U_{ss} |
| DC rated operational current | ≤ 200 mA |
| No-load current | ≤ 15 mA |
| Residual current | ≤ 0.1 mA |
| Switching frequency | 0.1 kHz |
| Oscillation frequency | According to EN 60947-5-2, 8.2.6.2 Table 9: 0.1...2.0 MHz |
| Isolation test voltage | ≤ 0.5 kV |
| Output function | 3-wire, NC contact, PNP |
| Short-circuit protection | yes / Cyclic |
| Voltage drop at I_o | ≤ 1.8 V |
| Wire breakage/Reverse polarity protection | yes / Complete |
| Approval acc. to | ATEX declaration of conformity TURCK Ex-03025H X |

Features

- M12 × 1 threaded barrel
- Plastic, PA12-GF30
- Fine adjustment via potentiometer
- DC 3-wire, 10...30 VDC
- NC contact, PNP output
- Cable connection
- ATEX category II 3 G, Ex zone 2
- ATEX category II 3 D, Ex zone 22

Wiring diagram

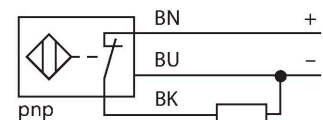

Functional principle

Capacitive proximity switches are designed for non-contact and wear-free detection of electrically conductive as well as non-conductive metal objects.

Technical data

| | |
|---------------------------------------|---|
| Device marking | Ex II 3 G Ex nA IIC T5 Gc / II 3 D Ex t IIIC T91°C Dc |
| Warning | Protect against mechanical damage |
| Mechanical data | |
| Design | Threaded barrel, M12 × 1 |
| Housing material | Plastic, PA12-GF30 |
| Active area material | PA12-GF30 |
| Admissible pressure on front cap | ≤ 8 bar |
| Max. tightening torque of housing nut | 1 Nm |
| Electrical connection | Cable |
| Cable quality | Ø 5.2 mm, LifYY-11Y, PUR, 2 m |
| Core cross-section | 3 x 0.34 mm ² |
| Vibration resistance | 55 Hz (1 mm) |
| Shock resistance | 30 g (11 ms) |
| Protection class | IP67 |
| MTTF | 1080 years acc. to SN 29500 (Ed. 99) 40 °C |
| Switching state | LED, Yellow |

Mounting instructions

Product features

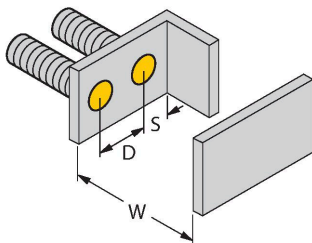
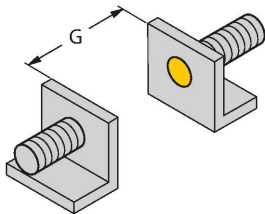

| | |
|------------|-------|
| Distance D | 24 mm |
|------------|-------|

| | |
|------------|------|
| Distance W | 9 mm |
|------------|------|

| | |
|------------|-------|
| Distance S | 18 mm |
|------------|-------|

| | |
|------------|-------|
| Distance G | 18 mm |
|------------|-------|

| | |
|------------------------|---------|
| Diameter active area B | Ø 12 mm |
|------------------------|---------|

The given minimum distances have been checked against the standard switching distance.
Should the sensitivity of the sensors be changed via potentiometer, the data sheet specifications no longer apply.

Accessories

MAP-M12-PP

6950016

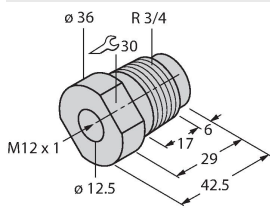

Mounting adapter; material: Polypropylene; sensor replacement with filled container possible (adapter remains in container during sensor replacement)

MAP-M12-PVDF

6950017

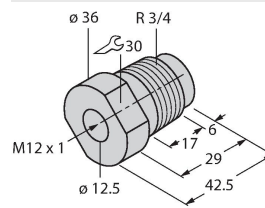

Mounting adapter; material: Polyvinylidenflourid; sensor can be replaced with filled container (adapter remains in container during replacement)

BST-12B

6947212

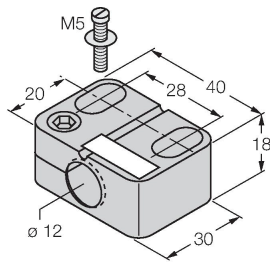

Mounting clamp for threaded barrel sensors, with dead-stop; material: PA6

Instructions for use

Intended use

This device fulfills the directive 2014/34/EC and is suited for use in explosion hazardous areas acc. to EN60079-0:2009, EN60079-15:2010 and EN60079-31:2009. In order to ensure correct operation to the intended purpose it is required to observe the national regulations and directives.

For use in explosion hazardous areas conform to classification

II 3 G and II 3 D (Group II, Category 3 G, electrical equipment for gaseous atmospheres and category 3 D, electrical equipment for dust atmospheres).

Marking (see device or technical data sheet)

Ex II 3 G and Ex nA IIC T5 Gc acc. to EN 60079-0:2009 and EN 60079-15:2010 and Ex II 3 D Ex t IIIC T91°C Dc acc. to EN 60079-0:2009 and EN 60079-31:2009

Installation/Commissioning

These devices may only be installed, connected and operated by trained and qualified staff. Qualified staff must have knowledge of protection classes, directives and regulations concerning electrical equipment designed for use in explosion hazardous areas. Please verify that the classification and the marking on the device comply with the actual application conditions.

Installation and mounting instructions

Avoid static charging of cables and plastic devices. Please only clean the device with a damp cloth. Do not install the device in a dust flow and avoid build-up of dust deposits on the device. If the devices and the cable could be subject to mechanical damage, they must be protected accordingly. They must also be shielded against strong electro-magnetic fields. The pin configuration and the electrical specifications can be taken from the device marking or the technical data sheet. In order to avoid contamination of the device, please remove possible blanking plugs of the cable glands or connectors only shortly before inserting the cable or opening the cable socket.

Special conditions for safe operation

Devices with terminal chamber (cable glands) have a weaker strain relief. Sufficient strain relief must be ensured or the cable must be stationary-mounted. Do not disconnect the plug-in connection or cable under voltage. Please attach a warning label permanently in an appropriate fashion in close proximity to the plug-in connection with the following inscription: Nicht unter Spannung trennen / Do not separate when energized. The device must be protected against any kind of mechanical damage and degrading UV-radiation. On selecting the approval-relevant accessories, always ensure that they are installed conform to the application. Load voltage and operating voltage of this equipment must be supplied from power supplies with safe isolation (IEC 30 364/UL508), to ensure that the rated voltage of the equipment (24 VDC +20% = 28.8 VDC) is never exceeded by more than 40%.

Service/Maintenance

Repairs are not possible. The approval expires if the device is repaired or modified by a person other than the manufacturer. The most important data from the approval are listed.