

# BC3-M12-AN6X-H1141

## Capacitive Sensor

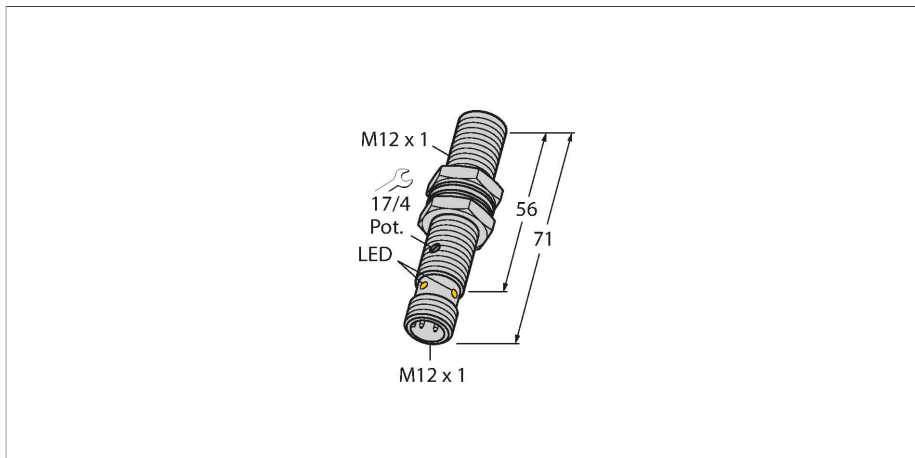

### Technical data

Type	BC3-M12-AN6X-H1141
ID	2601012
Rated switching distance (flush)	3 mm
Rated switching distance (non-flush)	3 mm
Secured operating distance	$\leq (0.72 \times S_n)$
Hysteresis	1...20 %
Temperature drift	Typical 20 %
Repeat accuracy	$\leq 2 \%$ of full scale
Ambient temperature	-25...+70 °C
<b>Electrical data</b>	
Operating voltage	10...30 VDC
Residual ripple	$\leq 10 \%$ $U_{ss}$
DC rated operational current	$\leq 200$ mA
No-load current	$\leq 15$ mA
Residual current	$\leq 0.1$ mA
Switching frequency	0.1 kHz
Oscillation frequency	According to EN 60947-5-2, 8.2.6.2 Table 9: 0.1...2.0 MHz
Isolation test voltage	$\leq 0.5$ kV
Output function	3-wire, NO contact, NPN
Short-circuit protection	yes / Cyclic
Voltage drop at $I_o$	$\leq 1.8$ V
Wire breakage/Reverse polarity protection	yes / Complete
<b>Tests/approvals</b>	
Approvals	UL
UL registration number	E210608

### Features

- M12 × 1 threaded barrel
- Chrome-plated brass
- Fine adjustment via potentiometer
- DC 3-wire, 10...30 VDC
- NO contact, NPN output
- M12 × 1 connector

### Wiring diagram

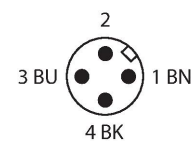
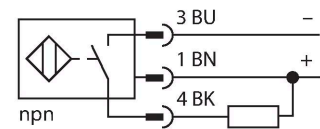

### Functional principle

Capacitive proximity switches are designed for non-contact and wear-free detection of electrically conductive as well as non-conductive metal objects.

## Technical data

Mechanical data	
Design	Threaded barrel, M12 × 1
Dimensions	71 mm
Housing material	Metal, CuZn, Chrome-plated
Active area material	ABS
Admissible pressure on front cap	≤ 5 bar
Max. tightening torque of housing nut	10 Nm
Electrical connection	Connector, M12 × 1
Vibration resistance	55 Hz (1 mm)
Shock resistance	30 g (11 ms)
Protection class	IP67
MTTF	1080 years acc. to SN 29500 (Ed. 99) 40 °C

## Mounting instructions

### Product features

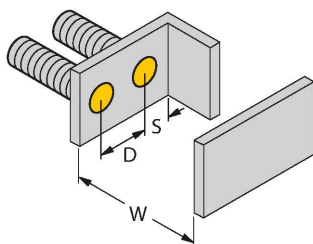
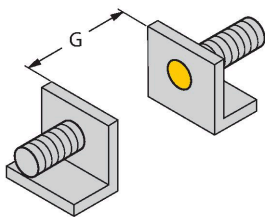

Distance D	24 mm
Distance W	9 mm
Distance S	18 mm
Distance G	18 mm
Diameter active area B	Ø 12 mm

The given minimum distances have been checked against the standard switching distance.  
Should the sensitivity of the sensors be changed via potentiometer, the data sheet specifications no longer apply.

## Accessories

### MAP-M12-PP

6950016

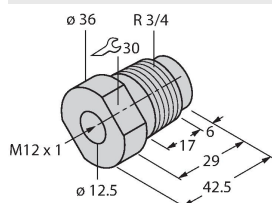

Mounting adapter; material: Polypropylene; sensor replacement with filled container possible (adapter remains in container during sensor replacement)

### MAP-M12-PVDF

6950017

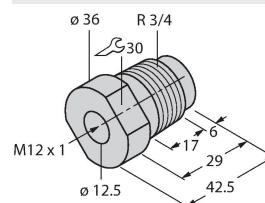

Mounting adapter; material: Polyvinylidenfluorid; sensor can be replaced with filled container (adapter remains in container during replacement)

**BST-12B** 6947212

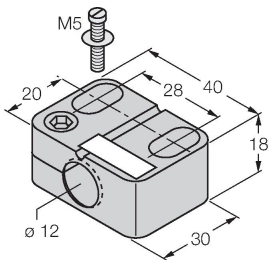

Mounting clamp for threaded barrel sensors, with dead-stop; material: PA6

**Accessories**

Dimension drawing	Type	ID	
	RKC4.4T-2/TXL	6625503	Connection cable, female M12, straight, 4-pin, cable length: 2 m, sheath material: PUR, black; cULus approval; other cable lengths and qualities available, see <a href="http://www.turck.com">www.turck.com</a>
	WKC4.4T-2/TXL	6625515	Connection cable, female M12, angled, 4-pin, cable length: 2 m, sheath material: PUR, black; cULus approval; other cable lengths and qualities available, see <a href="http://www.turck.com">www.turck.com</a>
	WKC4.4T-2/TEL	6625025	Connection cable, female M12, angled, 4-pin, cable length: 2 m, sheath material: PVC, black; cULus approval; other cable lengths and qualities available, see <a href="http://www.turck.com">www.turck.com</a>
	RKC4.4T-2/TEL	6625013	Connection cable, female M12, straight, 4-pin, cable length: 2 m, sheath material: PVC, black; cULus approval; other cable lengths and qualities available, see <a href="http://www.turck.com">www.turck.com</a>
	RKC4.4T-P7X2-10/TXL	6626184	Connection cable, female M12, angled, 4-pin, cable length: 10m, sheath material: PUR, black; cULus approval; other cable lengths and qualities available, see <a href="http://www.turck.com">www.turck.com</a>
	RKC4.4T-2-RSC4.4T/TEL	6625208	Connection cable, M12 female plug, straight, 4-pin, cable length: 2 m, sheath material: PVC, black; cULus approval; other cable lengths and qualities available, see <a href="http://www.turck.com">www.turck.com</a>

Dimension drawing	Type	ID	
	RKC4.4T-2-RSC4.4T/TXL	6625608	Extension cable, M12 female connector, straight, 4-pin to M12 male connector, straight, 4-pin; cable length: 2 m, jacket material: PUR, black; cULus approval; other cable lengths and versions available, see <a href="http://www.turck.com">www.turck.com</a>
	RKC4.4T-2-WSC4.4T/TXL	6625624	Extension cable, M12 female connector, straight, 4-pin; M12 male connector, angled, 4-pin; cable length: 2 m, jacket material: PUR, black; cULus approval; other cable lengths and qualities available, see <a href="http://www.turck.com">www.turck.com</a>
	WKC4.4T-2-WSC4.4T/TXL	6625656	Extension cable, M12 female connector, angled, 4-pin; M12 connector, angled, 4-pin; cable length: 2 m, jacket material: PUR, black; cULus approval; other cable lengths and qualities available, see <a href="http://www.turck.com">www.turck.com</a>