

Product data sheet

Specifications



inductive sensor XS1 M18 - L60mm
- brass - Sn5mm - 12..24VDC - M12
0.8m

XS1M18KPM40LD

⚠ Discontinued

Main

Range of product	Telemecanique Inductive proximity sensors XS
Series name	Application
Sensor type	Inductive proximity sensor
Device application	Factor 1 (Fe/Nfe)
Sensor name	XS1
Sensor design	Cylindrical M18
Size	60 mm
Body type	Fixed
Detector flush mounting acceptance	Flush mountable
Material	Metal
Enclosure material	Nickel plated brass
Type of output signal	Discrete
Wiring technique	4-wire
[Sn] nominal sensing distance	5 mm
Discrete output function	1 NO or 1 NC programmable
Output circuit type	DC
Discrete output type	PNP and NPN
Electrical connection	Remote male connector M12, 4 pins
Cable length	0.8 m
[Us] rated supply voltage	12...24 V DC with reverse polarity protection
Switching capacity in mA	<= 200 mA with overload and short-circuit protection
IP degree of protection	IP67 conforming to IEC 60529

Complementary

Thread type	M18 x 1
Detection face	Frontal
Front material	PPS
Operating zone	0...4 mm

Differential travel	1...15% of Sr
Repeat accuracy	3% of Sr
Wire insulation material	PvR
Status LED	Output state: 1 LED (yellow)
Supply voltage limits	10...38 V DC
Switching frequency	<= 1000 Hz
Maximum voltage drop	<2.6 V (closed)
Current consumption	0...15 mA no-load
Maximum delay first up	10 ms
Maximum delay response	0.3 ms
Maximum delay recovery	0.7 ms
Marking	CE
Threaded length	52 mm
Height	18 mm
Length	60 mm

Environment

Product certifications	CSA UL
-------------------------------	-----------

Contractual warranty

Warranty	18 months
-----------------	-----------

Dimensions

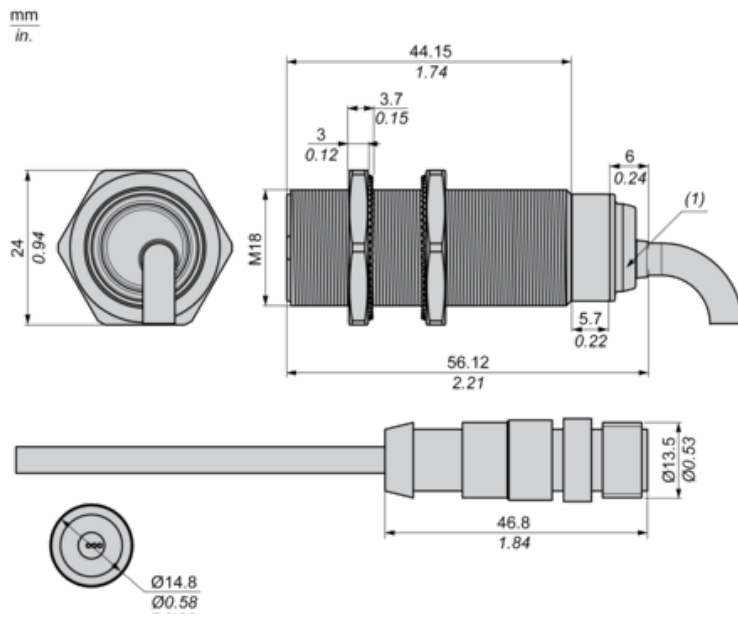

(1) LED

Minimum Mounting Distances

Side by side

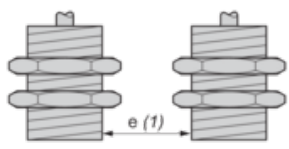

e (1) # 10 mm/0.39 in.

Face to face

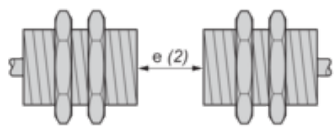

e (2) # 60 mm/2.36 in.

Facing a metal object

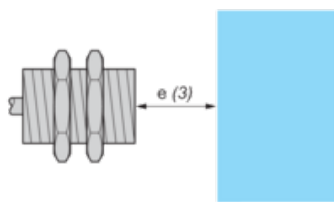

e (3) # 15 mm/0.60 in

Wiring Schemes

M12 Connector

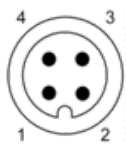

4-Wire DC, PNP/NPN, NO or NC output

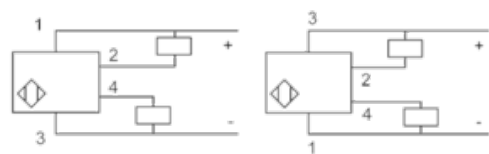

Performance Curves

Standard Steel Target : 18x18x1 mm

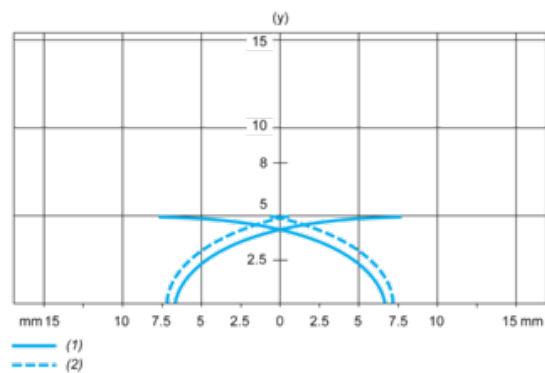

(1) Pick-up points

(2) Drop-out points (object approaching from the side)

(y) Sensing distance in mm

Recommended replacement(s)

XS1M18KPM40LD is replaced by the following product range:



Inductive and capacitive sensors XS & XT

Inductive and capacitive proximity sensors

Products: 1398